

TABBED PAGE

Index	Page
Aluminum	20
Closet Doors.....	4, 5, 13-19
French Doors	10
Hollow Core	3, 4
Lite Kits, Wood	6
Measuring Guides	1, 2, 9, 12
Mirrored.....	14-19
Panel Jacket.....	13, 14
Panel Swing Doors	11
Solid Core Doors	5
Steel Doors.....	6, 7
Steel Door Sidelites.....	8

MOULDINGS COLOR CHART



Mendocino

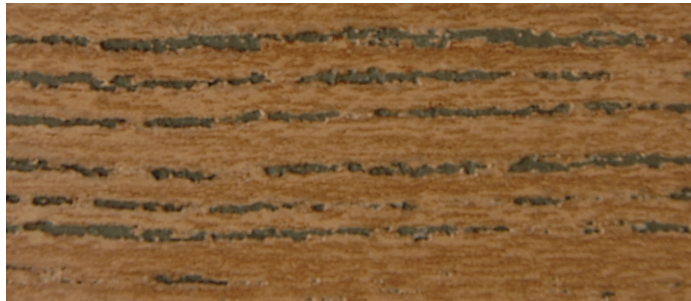

Natural Oak

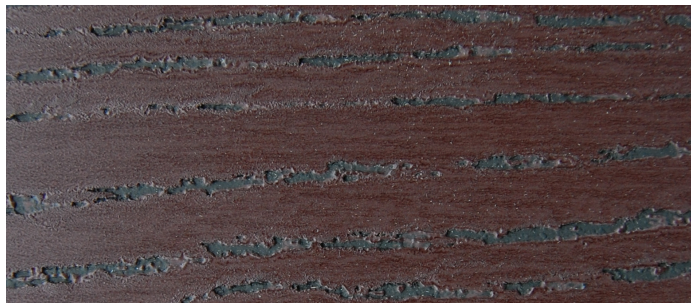

Walnut



Lite Oak

Interior Door Rough Openings

Pre-hung single doors	Width	Height
1-6 x 6-8	20"	82-1/2"
2-0 x 6-8	26"	82-1/2"
2-4 x 6-8	30"	82-1/2"
2-6 x 6-8	32"	82-1/2"
2-8 x 6-8	34"	82-1/2"
3-0 x 6-8	38"	82-1/2"

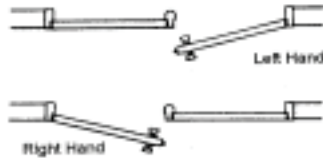

Interior Bifold Finished Openings

Pre-hung single doors	Width	Height
2-0 x 6-7	24"	81"
2-6 x 6-7	30"	81"
3-0 x 6-7	36"	81"
4-0 x 6-7	48"	81"
5-0 x 6-7	60"	81"
6-0 x 6-7	72"	81"

Carefully Make all door & hardware measurements and enter totals in boxes. Check boxes where indicated. Fill out order information. Repeat for each door ordered—We do the rest . . .

Will-Call
 Installed
 Delivered

Standard Hollow Core Door Height 80"
Standard Fire Door Height 79 1/4" & 80"

HEIGHT Inches

WIDTH Inches

Standard Door Slab Widths
17 13/16 - 23 13/16 - 27 13/16
29 13/16 - 31 13/16 - 35 13/16

THICKNESS - 1 3/8" 1 3/4"

LEGACY FINISH -
 Natural Oak Walnut Mendocino
 Lite Oak Other: _____
 Unfinished Oak

TYPE - Hollow Core Solid Core
FIRE RATING - Non-Rated 20 Min. 60 Min. 90 Min.

Measure Top of door to Center

Deadbolt/ Lockset Hole Diameter(s)

2 1/8" Inches

BACKSET
 2 3/8"
 2 3/4"

HINGE STYLE CHECK ONE

Hinge Radius/Style - Check One:
 A. 1/4" B. Square C. 5/8"

Hinge Size - Check One:
 3.5"x3.5" 4"x4" 4.5"x4.5"

D - Hinge Backset
 Standard 1/4"
 Other _____

Qty. _____ **DOOR SWING**

Left Hand
WHEN THE DOOR OPENS AT YOU WITH KNOB ON LEFT SIDE- It is a Left Hand Door.

Right Hand
WHEN THE DOOR OPENS AT YOU WITH KNOB ON RIGHT SIDE- It is a Right Hand Door.

LATCH STYLE CHECK ONE

SQUARE-CORNER LATCH

DRIVE-IN

ROUND CORNER LATCH

IMPORTANT! MEASURE ACCURATELY • PRINT CLEARLY • RE-CHECK ALL BEFORE ORDERING

Date: _____
Purchase Order No: _____
Customer Name: _____
Address: _____
City, State, Zip: _____

Signature: _____
Job Name: _____
Telephone: (____) _____
Fax Number: (____) _____
Building No.: _____ Apt. No.: _____

TO ORDER FAX THIS PAGE TO: (612) 729-4216

Or Mail To: EMPIRE DOOR • 3415 EAST 27TH STREET • MINNEAPOLIS, MN 55406

- Will-Call
- Installed
- Delivered

Pre-Hung

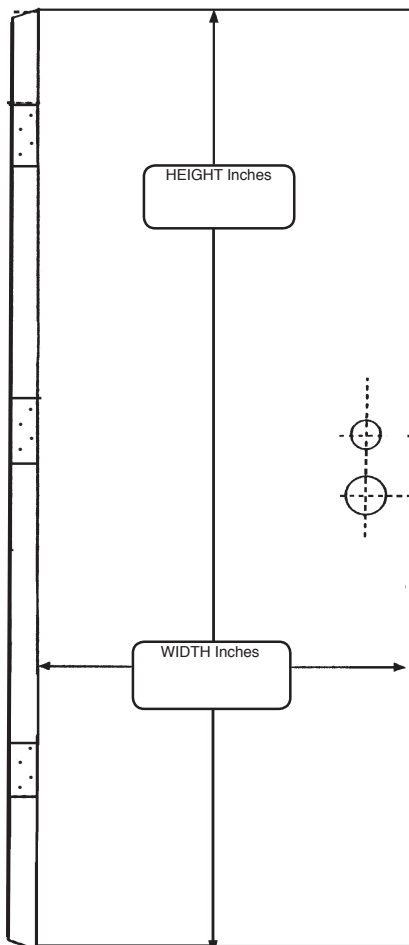

Standard Widths

1'6 - 2'0 - 2'4 - 2'6 - 2'8 - 3'0

Standard Height

For Hollow Cores - 80"

Standard Height

For Solid Cores

79 1/4" and 80"

Hinge Color:

- ___ Antique brass
- ___ Bright Brass
- ___ Dull Chrome
- ___ Other

New Lockset

Style _____

Color _____

Quantity _____

DOOR SWING

Left Hand

WHEN THE DOOR OPENS TO YOU WITH KNOB ON LEFT SIDE- It is a Left Hand Door.



Right Hand

WHEN THE DOOR OPENS AT YOU WITH KNOB ON RIGHT SIDE- It is a Right Hand Door.

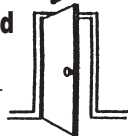

THICKNESS - 1 3/8" 1 3/4"



LEGACY FINISH -

- Natural Oak Walnut Mendocino
- Lite Oak Unfinished Oak
- Other _____

TYPE - Hollow Core Solid Core

Casing:

One side _____

Both sides _____

Standard: Ranch

Bore:

Single _____

Double _____

Standard

Jamb Thickness:

4 9/16" - 4 13/16" - 5 1/4"

6 9/16" - 6 13/16"

Other _____

Standard backset: 2 3/4"

or 2 3/8" _____

LATCH STYLE

SQUARE-CORNER LATCH



STANDARD DRIVE-IN



ROUND CORNER LATCH

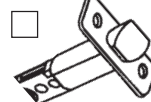

IMPORTANT! MEASURE ACCURATELY • PRINT CLEARLY • RE-CHECK ALL BEFORE ORDERING

Date: _____

Management Co.: _____

Purchase Order No: _____

Contact Person: _____

Customer Name: _____

Telephone: (____) _____

Address: _____

Fax Number: (____) _____

City, State, Zip: _____

Building No.: _____ Apt. No.: _____

TO ORDER FAX THIS PAGE TO: (612) 729-4216

Or Mail To: EMPIRE DOOR • 3415 EAST 27TH STREET • MINNEAPOLIS, MN 55406

PREFINISHED 1 3/8" HOLLOW CORE DOORS

Pre-hung Door Configuration

Doors are pre-hung in a frame consisting of 4-9/16" veneer jamb with stop applied. 3 - 3-1/2" hinges and 2 sides of standard casing. Other standard jamb thickness are 4 13/16 - 5 1/4 - 6 9/16 - 6 13/16.



Walnut



Mendocino



Natural Oak



Lite Oak

Pre-hung doors	Walnut	Mendocino	Natural Oak	Lite Oak
1-6 x 6-8	*	*	*	*
2-0 x 6-8	*	*	*	*
2-4 x 6-8	*	*	*	*
2-6 x 6-8	*	*	*	*
2-8 x 6-8	*	*	*	*
3-0 x 6-8	*	*	*	*

Slabs	All slabs are undercut 3/16" in width bevelled 1 side			
1-6 x 6-8	Stock	Stock	Stock	Stock
2-0 x 6-8	Stock	Stock	Stock	Stock
2-4 x 6-8	Stock	Stock	Stock	Stock
2-6 x 6-8	Stock	Stock	Stock	Stock
2-8 x 6-8	Stock	Stock	Stock	Stock
3-0 x 6-8	Stock	Stock	Stock	Stock

Bifolds	All slabs are undercut 3/16" in width bevelled 1 side			
2-0 x 6-7	Stock	Stock	Stock	Stock
2-6 x 6-7	Stock	Stock	Stock	Stock
3-0 x 6-7	Stock	Stock	Stock	Stock
4-0 x 6-7	Stock	Stock	Stock	Stock
5-0 x 6-7	Stock	Stock	Stock	Stock
6-0 x 6-7	Stock	Stock	Stock	Stock

See page 2
for your door
measuring guide

* Call for Availability
--- Special Order
Custom Sizes Available

See page 33 in the
door hardware section
for new hinges

FLUSH 1 3/8" HOLLOW CORE DOORS

Pre-hung Door Configuration

Doors are pre-hung in a frame consisting of 4-9/16" veneer jamb with stop applied. 3 - 3-1/2" hinges and 2 sides of standard casing.
Other standard jamb thickness are 4 13/16 - 5 1/4 - 6 9/16 - 6 13/16.

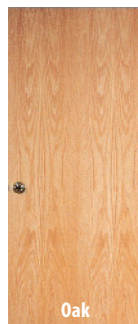

Oak

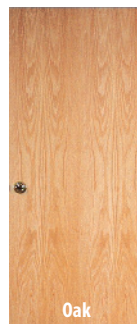

Oak

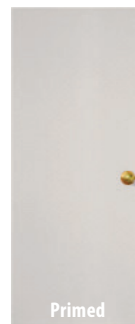

Primed



Birch

Pre-hung doors	Oak 1-3/8" Premium Plain Sliced	Oak 1-3/4" Premium Plain Sliced	Primed Hardboard	Birch Uniform Lite
1-6 x 6-8	*	---	*	*
2-0 x 6-8	*	---	*	*
2-4 x 6-8	*	---	*	*
2-6 x 6-8	*	*	*	*
2-8 x 6-8	*	*	*	*
3-0 x 6-8	*	*	*	*

Slabs (all doors are undercut 3/16" beveled 1 side)	Oak 1-3/8" Premium Plain Sliced	Oak 1-3/4" Premium Plain Sliced	Primed Hardboard	Birch Uniform Lite
1-6 x 6-8	*	---	*	*
2-0 x 6-8	*	---	*	*
2-4 x 6-8	*	---	*	*
2-6 x 6-8	*	*	*	*
2-8 x 6-8	*	*	*	*
3-0 x 6-8	*	*	*	*

Bifolds	Oak 1-3/8" Premium Plain Sliced	Oak 1-3/4" Premium Plain Sliced	Primed Hardboard	Birch Uniform Lite
2-0 x 6-7	*	---	*	*
2-6 x 6-7	*	---	*	*
3-0 x 6-7	*	---	*	*
4-0 x 6-7	*	---	*	*
5-0 x 6-7	*	---	*	*
6-0 x 6-7	*	---	*	*

See page 2
for your door
measuring guide

* Call for Availability
--- Special Order
Custom Sizes, staining, or painting available

FLUSH SOLID CORE DOORS

Pre-hung Door Configuration





Doors are pre-hung in a frame consisting of 4-9/16" veneer jamb with stop applied. 3 - 4" hinges and 2 sides of standard casing. Custom jamb thickness available.

Pre-hung doors	Oak 1-3/4" Premium Plain Sliced	Oak 1-3/8" Premium Plain Sliced	Birch 1-3/4" Rotary Select White	Birch 1-3/8" Rotary Uniform Lite	Legacy Walnut Mendocino Natural Oak Lite Oak	Primed Hardboard
2-0 x 6-8	*	*	*	*	---	---
2-4 x 6-8	*	*	*	*	---	---
2-6 x 6-8	*	*	*	*	---	---
2-8 x 6-8	*	*	*	*	---	---
3-0 x 6-8	*	*	*	*	---	---
2-8 x 7-0	*	---	---	---	---	---
3-0 x 7-0	*	---	---	---	---	---

Slabs	Oak 1-3/4" Premium Plain Sliced	Oak 1-3/8" Premium Plain Sliced	Birch 1-3/4" Rotary Select White	Birch 1-3/8" Rotary Uniform Lite	Legacy Walnut Mendocino Natural Oak Lite Oak	Primed Hardboard
2-0 x 6-8	*	*	*	*	---	---
2-4 x 6-8	*	*	*	*	---	---
2-6 x 6-8	*	*	*	*	---	---
2-8 x 6-8	*	*	*	*	---	---
3-0 x 6-8	Stock	*	*	*	Stock	---
2-8 x 79-1/4"	*	---	*	---	---	---
3-0 x 79-1/4"	Stock	---	*	---	Stock	*
3-0 x 83-1/4"	*	---	*	---	---	*

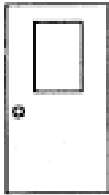
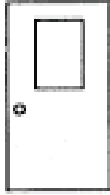
WOOD DOOR LITES

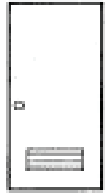
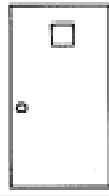
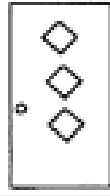
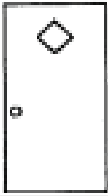
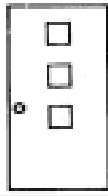
Lites have 1/8" tempered glass with alder surrounds.

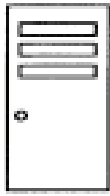
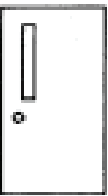
				
For 1-3/8" or 1-3/4" thick doors	20" x 24" lite 2024-A	22" x 36" lite 2236-A	20" x 20" louver	20" x 8" louver
				
For 1-3/8" or 1-3/4" thick doors	10" x 10" lite 1010-A	22" x 36" lites 1010-R	10" x 10" lite 1010-S	10" x 10" lites 1010-T
				
For 1-3/8" or 1-3/4" thick doors	4" x 24" lite 0424-A	4" x 24" lites 0424-U	4" x 24" lite 0424-V	

Custom painting
and staining
available.

See pages 35-37
in the door
hardware section
for new hinges.

* Call for Availability
--- Special Order
Custom Sizes, staining, or painting available

18 GAUGE COMMERCIAL STEEL DOORS

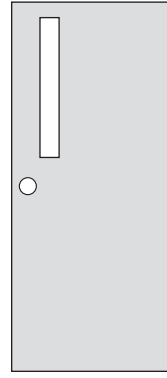
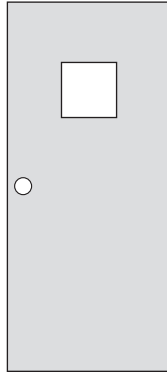
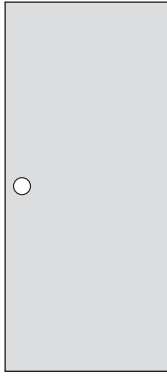

Standard Door Sizes

Widths 2'6, 2'8, 3'0, 3'4, 3'6.

Heights 6'8, and 7'0

Custom Sizes Available.

COMMERCIAL STEEL LITE KITS

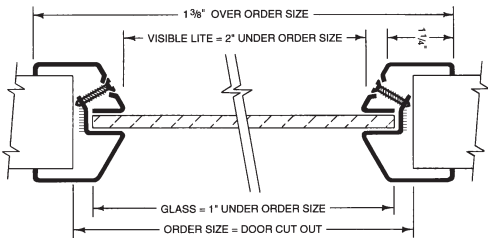

Model VLF-EZ

Beveled VISION LITE with continuous glass retainer

Recommended for applications where total visibility and light transmissions are required.

Specifications

Standard Features:

Material: 20 Gauge CRS frame.

Construction: Mitered and welded corners, beveled return, continuous glass retainer, countersunk mounting holes. Screws fasten from room side into prepunched mounting holes. This mounting method leaves corridor side of frame free of fasteners for aesthetic and security purposes.

Finish: Mineral bronze baked on powder coat.

Door: For 1-3/4" door.

Fasteners: #8 x 7/8" flathead phillips head SMS.

Glass: Use 3/16", 1/4" fire rated glazing with Warnock Hersey (ITS) or U.L. classification markings for fire rated applications.



Order to cut size

6 x 27
12 x 12
24 x 30
24 x 36
24 x 36
24 x 54
24 x 62
12 x 12
24 x 30
24 x 36
24 x 62
24 x 66

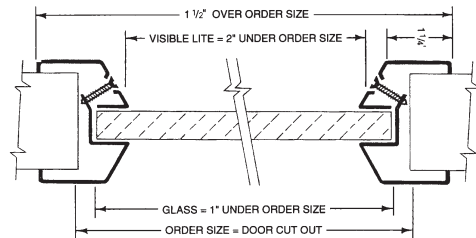

Model VLF-EZ-IG

Beveled VISION LITE with continuous glass retainer

Recommended for applications requiring fire rated, safety, and or insulated glazing up to 1" thick.

Specifications

Standard Features:

Material: 20 Gauge CRS frame.

Construction: Mitered and welded corners, beveled return, continuous glass retainer, countersunk mounting holes. Screws fasten from room side into prepunched mounting holes. This mounting method leaves corridor side of frame free of fasteners for aesthetic and security purposes.

Door: For 1-3/8" door up to 2 1/2" thick.

Finish: Mineral bronze baked on powder coat.

Fasteners: #8 x 7/8" flathead phillips head SMS.

Glass: Use 1/4"- 1" thick glass. Please specify glass thickness when ordering.

60 & 90 minute fire doors cannot exceed 100 square inches of exposed glass.

20 minute fire doors cannot exceed 1296 square inches of exposed glass.

Fire rated glass must be used in all fire rated doors.

COMMERCIAL STEEL 16 GAUGE FRAMES

Knockdown (KD) Frames

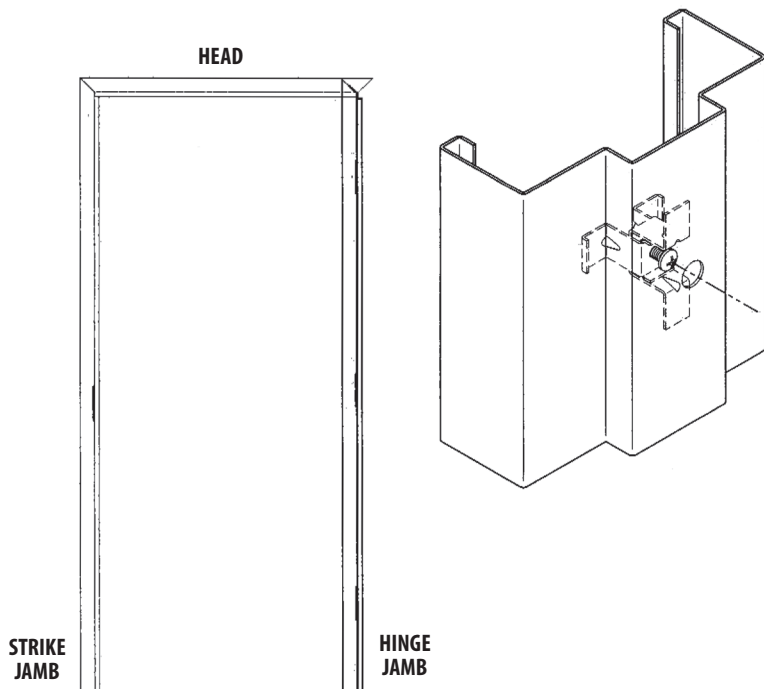

- A frame is made of three members, two jambs and one head.
- A Comprehensive Anchor is used to compress the header between the two joints.
- As the adjustment screw is turned, the anchor pushes against the stud wall and locks the header in place.
- It is also known as a Pressure Anchor.
- This anchor is used on drywall frames, and in conjunction with the Snap-In Drywall Sill Anchor.

Welded Frames

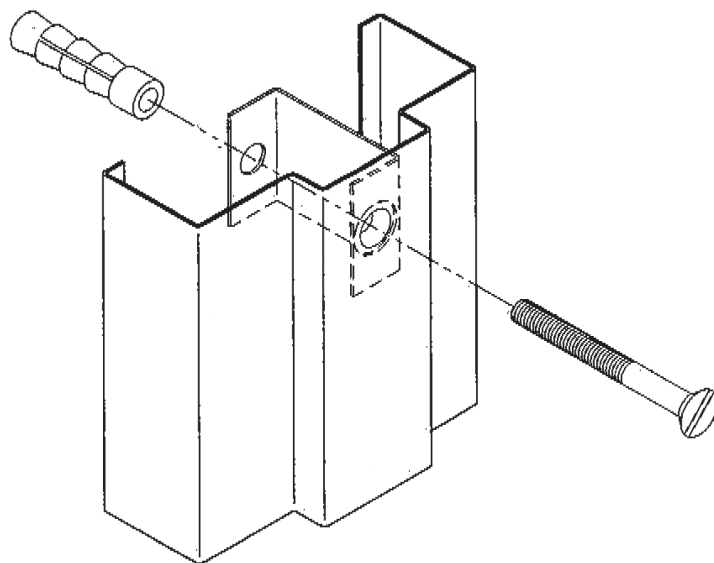

- These 1 piece frames come with a standard 2" face
- Non- standard FACE dimensions are available upon request. 1"-1 1/4"-1 1/2"
- Punched & Dimpled Frames may be required, depending on the type of anchor used.

Need Help?
Ask your sales representative to come visit you









Standard Jamb Thickness 4 3/4 - 5 3/4 - 6 1/4 - 6 3/4 - 7 1/4 - 7 3/4 - 8 3/4
90 minute lables available for fire rated applications.
For commercial steel doors see page 3 in the Fire Door section.



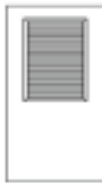

RESIDENTIAL STEEL DOORS

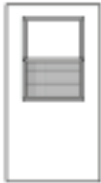

24 Gauge Steel Edge

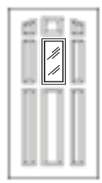
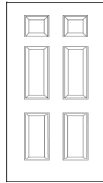
Standard PH Price Configuration:

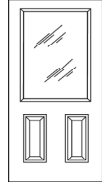
4-9/16" Frame Saver® rot-proof primed exterior frame components with compression weatherstrip, Z-series inswing adjustable composite sill, sill cover, applied rot-proof brickmould and single bore. Custom jamb thickness available.

							
HDA	closer/panic HDA-CP	raise/lower/tilt HDA-B106-010	white internal raise/lower/tilt HDA-B106-091W	low-e HDA-106-010	clear 1" G HDA-106-010	vent HDA-106-160	clear IG HDA-106-010

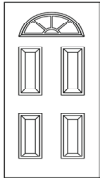
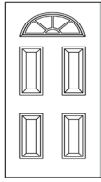
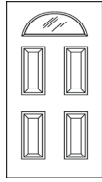
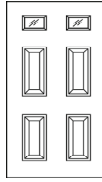
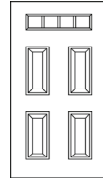
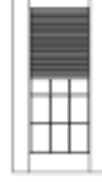
						
HDA-122LE	clear 1" IG HDJ-136-010	panic/prep HDG-CP	clear low-e HDG-106-LE	clear 1" IG HDG-106-LE	vent HDG-106-160	raise/lower/tilt HDG-106-160

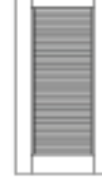
							
fixed external HDD-135-05E	internal white HDD-135-051W	clear 1" IG HDD-135-010	clear 1" IG HDG-680-010	fixed grid HDG-822-04E	white internal raise/lower/tilt HDA-B122-151W	raise/lower/tilt HDA-B122-010	shade w/raise/lower HDA-B122-010

						
internal sand HDG-106-091T	internal white HDG-106-091W	removable white HDG-106-091W	removable wood low-e HDG-106-09WGLE	internal sand HDA-122-151T	internal white HDA-122-151W	removable wood low-e HDA-122-15WGLE

2-8x6-8 and 3-0x6-8
Custom Painting Available

12" / 14" SIDELITES

Continuous header and sill on prehung units

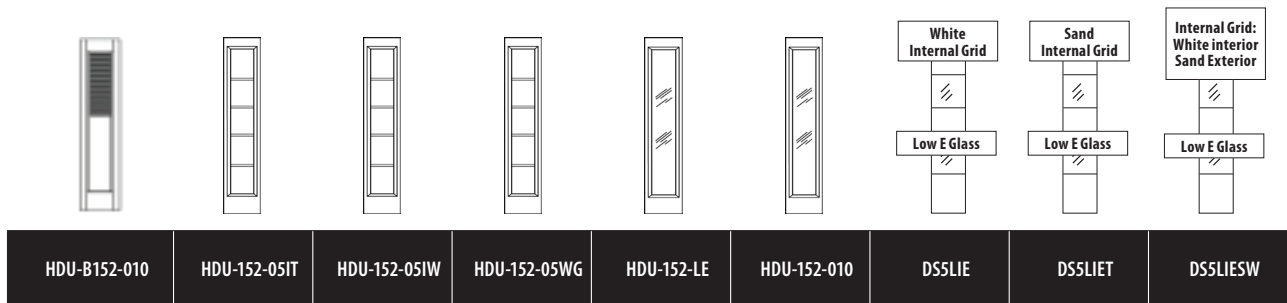

Sill Profile Illustrations

Adjustable Sill

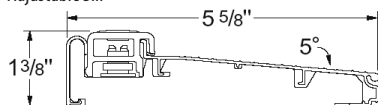

Bumper Outswing Sill

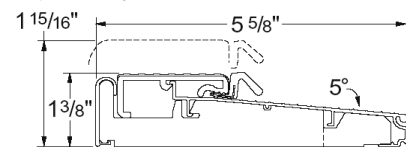

Handicap Inswing Sill

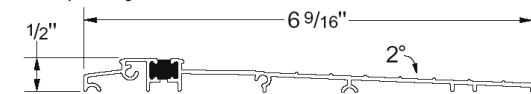

Handicap Outswing Sill



Primed Jamb

		Standard Sills	Handicap In-Swing	Handicap Out-Swing	Bumper Out-Swing
6-8	RO	82-1/8"	81-1/4"	81-1/8"	81-3/8"
	UD	81-11/16"	80-3/4"	80-3/4"	80-15/16"
	BM	82-15/16"	82-1/16"	82-1/4"	82-1/2"
7-0	RO	86-1/8"	85-1/4"	85-1/8"	85-3/8"
	UD	85-11/16"	84-3/4"	84-3/4"	84-15/16"
	BM	86-15/16"	86-1/16"	86-1/4"	86-1/2"

BM = bottom of sill to top of brickmold measurement. The Clad in-swing dimension is calculated using the Crownline brickmold profile. For classic brickmold, add 1 1/4" to the respective UD height (inswing only).

Clad Jamb

		Standard Sills	Handicap In-Swing	Handicap Out-Swing	Bumper Out-Swing
6-8	RO	81-15/16"	81-1/16"	80-15/16"	81-3/16"
	UD	81-11/16"	80-3/4"	80-13/16"	81"
	BM	82-1/4"	81-5/16"	81-3/8"	81-9/16"
7-0	RO	85-15/16"	85-1/16"	84-15/16"	85-3/16"
	UD	85-11/16"	84-3/4"	84-13/16"	85"
	BM	86-1/4"	85-5/16"	85-3/8"	85-9/16"

BM may vary 1/16" +/-

MEASURING GUIDE FOR RESIDENTIAL STEEL DOORS

Single Door

(width)		Primed In-swing	Primed Out-swing	Clad In-swing	Clad Out-swing
2-0	RO	26-1/2"	26-1/2"	26"	26"
	UD	25-1/2"	25-1/2"	25-1/2"	25-1/2"
	BM	28"	28-1/2"	26-5/8"	26-1/2"
2-4	RO	30-1/2"	30-1/2"	30"	30"
	UD	29-1/2"	29-1/2"	29-1/2"	29-1/2"
	BM	32"	32-1/2"	30-5/8"	30-1/2"
2-6	RO	32-1/2"	32-1/2"	32"	32"
	UD	31-1/2"	31-1/2"	31-1/2"	31-1/2"
	BM	34"	34-1/2"	32-5/8"	32-1/2"
2-8	RO	34-1/2"	34-1/2"	34"	34"
	UD	33-1/2"	33-1/2"	33-1/2"	33-1/2"
	BM	36"	36-1/2"	34-5/8"	34-1/2"
2-10	RO	36-1/2"	36-1/2"	36"	36"
	UD	35-1/2"	35-1/2"	35-1/2"	35-1/2"
	BM	38"	38-1/2"	36-5/8"	36-1/2"
3-0	RO	38-1/2"	38-1/2"	38"	38"
	UD	37-1/2"	37-1/2"	37-1/2"	37-1/2"
	BM	40"	40-1/2"	38-5/8"	38-1/2"
3-6	RO	44-1/2"	44-1/2"	44"	44"
	UD	43-1/2"	43-1/2"	43-1/2"	43-1/2"
	BM	46"	46-1/2"	44-5/8"	44-1/2"

In-swing

RO = Rough Opening

UD = Unit Dimension (outside of jamb to outside of jamb measurement). UD may vary 1/16" +/-

BM = outside of Brickmould to outside of brickmould measurement. The Clad In-Swing dimension is calculated using the Crownline brickmould profile. For Clad In-Swing brickmould, add 2-9/16" to the Clad In-swing UD.

BM may vary 1/16" +/-

Single Door w/ Single 12" Sidelite (width)

2-8	RO	47-15/16"	47-15/16"	47-9/16"	48-3/4"
	UD	47"	47"	47"	48-1/4"
	BM	49-1/2"	49-3/4"	48-1/8"	49-3/8"
3-0	RO	51-15/16"	51-15/16"	51-9/16"	52-3/4"
	UD	51"	51"	51"	52-1/4"
	BM	53-1/2"	53-3/4"	52-1/8"	53-3/8"

Spread Mulls

To calculate the width of the spread mull, add the width of the spread mull(s) to the appropriate opening.

Single Door w/ Double 12" Sidelite (width)

2-8	RO	61-7/16"	61-7/16"	61-1/16"	63-5/8"
	UD	60-1/2"	60-1/2"	60-1/2"	63"
	BM	63"	63-1/4"	61-5/8"	64-1/8"
3-0	RO	65-7/16"	65-7/16"	65-1/16"	67-5/8"
	UD	64-1/2"	64-1/2"	64-1/2"	67"
	BM	67"	67-1/4"	65-5/8"	68-1/8"

61-1/16"

60-7/16"

65-1/16"

64-7/16"

Single Door w/ Single 14" Sidelite (width)

2-8	RO	49-15/16"	49-15/16"	49-9/16"	50-3/4"
	UD	49"	49"	49"	50-1/4"
	BM	51-1/2"	51-3/4"	50-1/8"	51-3/8"
3-0	RO	53-15/16"	53-15/16"	53-9/16"	54-3/4"
	UD	53"	53"	53"	54-1/4"
	BM	55-1/2"	55-3/4"	54-1/8"	55-3/8"

49-9/16"

48-15/16"

53-9/16"

52-15/16"

Single Door w/ Double 14" Sidelite (width)

2-8	RO	65-7/16"	65-7/16"	65-1/16"	67-5/8"
	UD	64-1/2"	64-1/2"	64-1/2"	67"
	BM	67"	67-1/4"	65-5/8"	68-1/8"
3-0	RO	69-7/16"	69-7/16"	69-1/16"	71-5/8"
	UD	68-1/2"	68-1/2"	68-1/2"	71"
	BM	71"	71-1/4"	69-5/8"	72-1/8"

65-1/16"

64-7/16"

69-1/16"

68-7/16"

FRENCH DOORS

Continuous header and sill on prehung units

1-3/8" doors are pre-hung in a frame consisting of 4-9/16" veneer jamb with stop applied, 1-1/2 pair of 3-1/2" ball bearing hinges and 2 sides of standard casing.

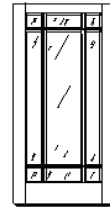
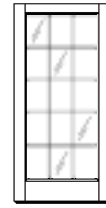
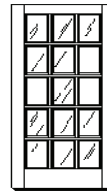
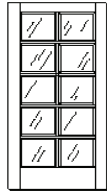

Pre-hung or Slab Doors	2-3/8" backset Oak 1501	2-3/8" backset Oak 1510	2-3/8" backset Oak 1515	(hung w/bevels on top side 2-3/8" backset Oak Visionary	2-3/8" backset Oak 1509
2-0 x 6-8	*	*	---	*	*
2-6 x 6-8	*	---	*	*	*
2-8 x 6-8	*	---	*	*	---
3-0 x 6-8	*	---	*	*	*

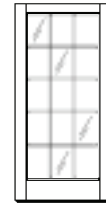
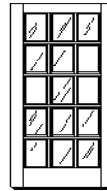
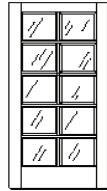
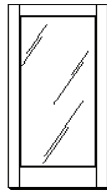

Pre-hung or Slab Doors	2-3/8" backset Maple 1501	2-3/8" backset Maple 1510	2-3/8" backset Maple 1515	(hung w/bevels on top side 2-3/8" backset Maple Visionary
2-0 x 6-8	*	*	---	*
2-4 x 6-8	---	---	---	---
2-6 x 6-8	*	---	*	*
2-8 x 6-8	---	---	---	---
3-0 x 6-8	*	---	*	*

If you don't see the style you want call our sales dept.

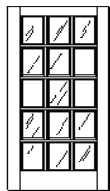
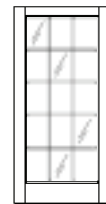
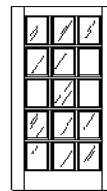
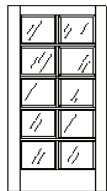
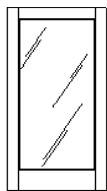

Pre-hung or Slab Doors	2-3/8" backset Pine 1501	2-3/8" backset Pine 1510	2-3/8" backset Pine 1515	2-3/8" backset Primed 1515	2-3/8" backset Primed 1515
2-0 x 6-8	*	*	---	*	---
2-4 x 6-8	---	---	---	---	---
2-6 x 6-8	*	---	*	---	*
2-8 x 6-8	*	---	*	---	*
3-0 x 6-8	*	---	*	---	*

* Call for Availability
 --- Special Order
 Custom staining and painting available

WOOD PANEL DOORS

1-3/8" doors are pre-hung in a frame consisting of 4-9/16" veneer jamb with stop applied, 3-1/2" ball bearing hinges and 2 sides of standard casing.

Pre-hung and Slab Doors	Bifolds
1-6 x 6-8	2-0 x 6-7
2-0 x 6-8	2-6 x 6-7
2-4 x 6-8	3-0 x 6-7
2-6 x 6-8	4-0 x 6-7
2-8 x 6-8	5-0 x 6-7
3-0 x 6-8	6-0 x 6-7

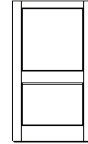
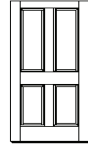
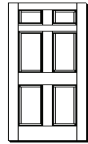
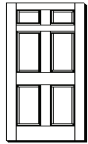

Oak A6D 3/4" veneered dbl hip raised ovolo sticking	Oak B6 Regal 3/4" veneered raised panel ovolo sticking	Oak A4 3/4" veneered raised panel ovolo sticking	Oak B2 3/4" veneered raised panel ovolo sticking	Oak A2 3/8" veneered flat panel ovolo sticking	Oak A3 2 3/8" backseat 3/4" veneered flat panel ovolo sticking
---	--	--	--	--	--

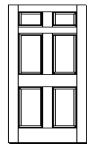
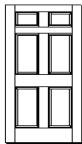

Clear Pine A6 9/16" solid raised panel ovolo sticking	Knotty Pine A6 3/4" veneer dbl hip raised panel ovolo sticking	Knotty Pine B2 3/4" veneer dbl hip raised panel ovolo sticking	Knotty Pine C2 3/4" plank flat panel square sticking	Knotty Pine F2 3/4" plank flat panel square sticking
---	--	--	--	--

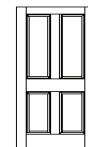
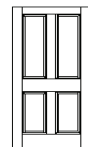
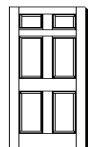
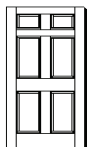

Solid Core Primed A6 Smooth or Textured Skin	Hollow Core Primed A6 Smooth or Textured Skin	Solid Core Primed A4 Smooth Skin	Hollow Core Primed A4 Smooth Skin
--	---	--	---

Custom painting and staining available.

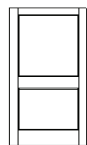
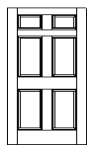

Maple A6 11/16" veneered raised panel ovolo sticking	Maple A2 3/8" veneered flat panel square sticking	Maple A3 2-3/8" backseat 3/8" veneered flat panel square sticking
--	---	---

Custom staining and painting available

DOOR SIZING GUIDE FOR BIFOLD AND BYPASS DOORS

Date of Bid _____ Customer P.O. # _____
 Name _____
 Address _____
 City, State, Zip _____
 Phone # _____ Fax # _____
 Location: Bldg. # _____ Apt. # _____
 Salesperson _____

Please "X" the Appropriate Box
 Installed
 Delivered
 Will Call
 Complete Set
 Panel Only Frame Size _____
 Skin Only Size _____

PANEL DOOR STYLE

- Framed Panel Bifold
- Framed Panel Bypass

CHOOSE PANEL FINISH

- Natural Oak
- Dark Walnut
- Mendocino
- Crystal White
- Lite Oak

MIRRORED DOOR STYLE

- Framed Bypass
- Framed Bifold
- Frameless Bypass
- Frameless Bifold
- Economy Framed Bypass

*All doors are built with Category 2 safety backing

FRAME COLOR

- White Artic Silver
- Satin Gold
- Other _____

1 3/8" HOLLOW CORE BIFOLD CLOSET DOORS LEGACY COLORS

- Natural Oak
- Dark Walnut
- Mendocino
- Lite Oak
- Other _____

FINISHED OPENING SIZE

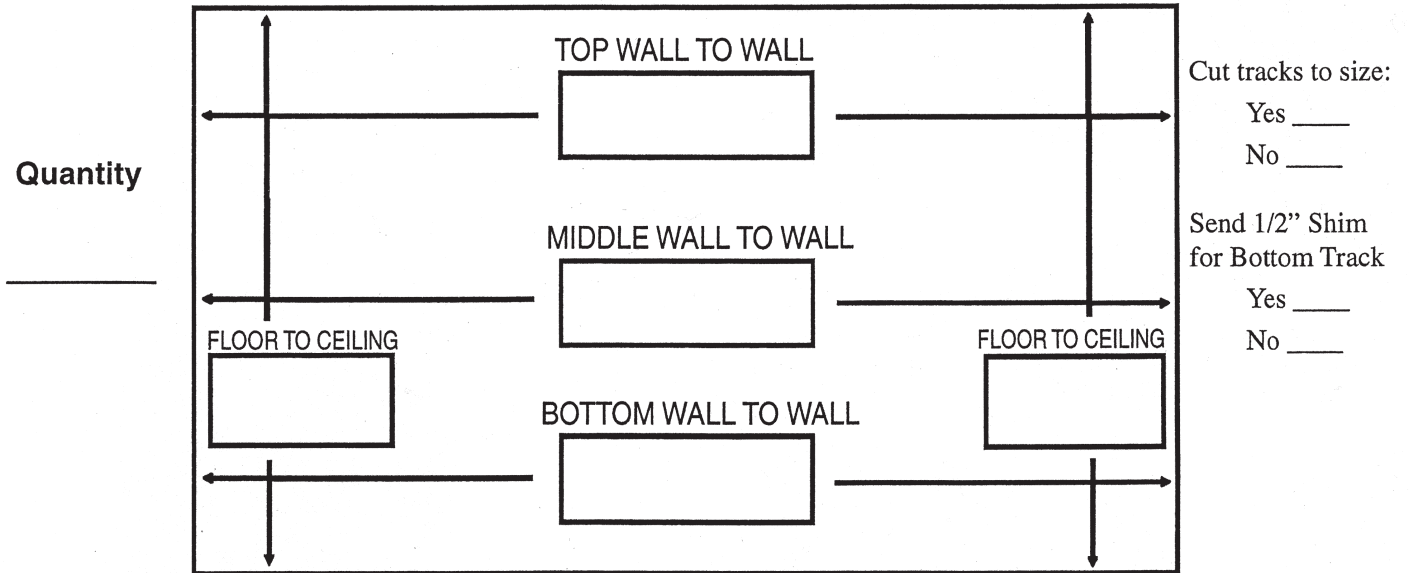

I understand that by signing this agreement, I am agreeing that the measurements, and all other specifications such as color, door sizing, and the entire list of specifications, are correct and that doors delivered to me with these measurements and specifications become my responsibility.

Doors that are shipped to me that do not meet these measurements and specifications are the responsibility of Empire.

Signed _____ Date _____

Representing _____

BYPASS PANEL CLOSET DOORS

Standard Finished Opening Sizes
48 x 80 1/2 (2 Door)
60 x 80 1/2 (2 Door)
72 x 80 1/2 (2 Door)
84 x 80 1/2 (2 Door)
96 x 80 1/2 (2 Door)
108 x 80 1/2 (3 Door)
120 x 80 1/2 (3 Door)
144 x 80 1/2 (3 Door)
192 x 80 1/2 (4 Door)

Standard Finished Opening Sizes
48 x 96 (2 Door)
60 x 96 (2 Door)
72 x 96 (2 Door)
84 x 96 (2 Door)
96 x 96 (2 Door)
108 x 96 (3 Door)
120 x 96 (3 Door)
144 x 96 (3 Door)
192 x 96 (4 Door)

* Heavy Duty Panels Available using a 7/16" solid backing with top roller # 52030 and bottom roller #51040 (see page 16 for picture of hardware).

3 Stock Frame Colors

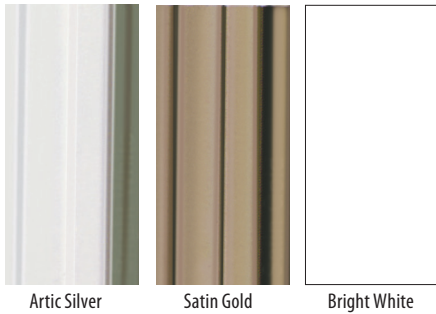

5 Stock Panel Colors



3-4 mm Top Roll Framed Sliding Door System

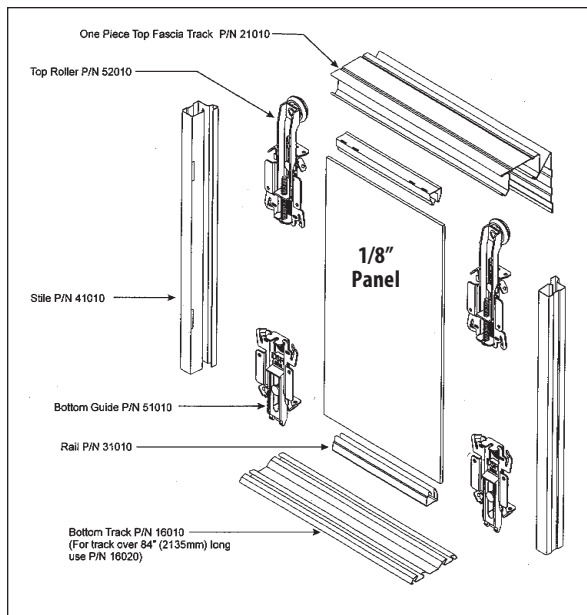

Custom Sizes Available

BIFOLD PANEL CLOSET DOORS

Standard Finished Opening Sizes
24 x 96 (2 Door)
30 x 96 (2 Door)
36 x 96 (2 Door)
48 x 96 (4 Door)
60 x 96 (4 Door)
72 x 96 (4 Door)

Standard Finished Opening Sizes
24 x 80 1/2 (2 Door)
30 x 80 1/2 (2 Door)
36 x 80 1/2 (2 Door)
48 x 80 1/2 (4 Door)
60 x 80 1/2 (4 Door)
72 x 80 1/2 (4 Door)

----- 2 Stock Frame Colors -----



Artic Silver

Bright White

----- 5 Stock Panel Colors -----

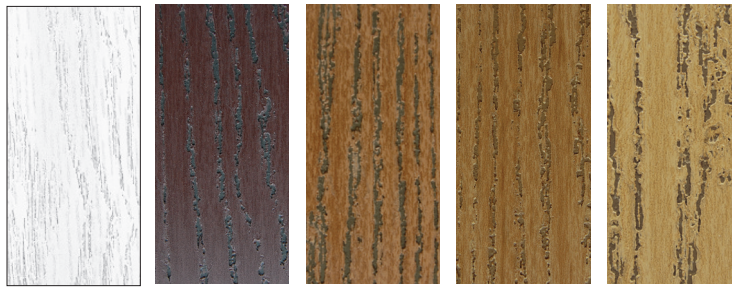

Crystal White

Walnut

Natural Oak

Mendocino Oak

Lite Oak

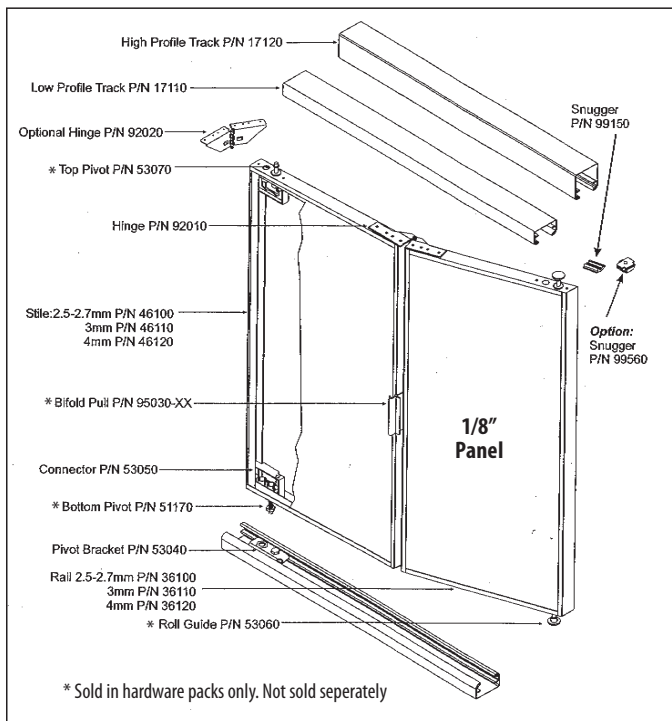

Custom Sizes Available

BYPASS FRAMED MIRRORED CLOSET DOORS

Standard Finished Opening Sizes
48 x 80 1/2 (2 Door)
60 x 80 1/2 (2 Door)
72 x 80 1/2 (2 Door)
84 x 80 1/2 (2 Door)
96 x 80 1/2 (2 Door)
108 x 80 1/2 (3 Door)
120 x 80 1/2 (3 Door)
144 x 80 1/2 (3 Door)
192 x 80 1/2 (4 Door)

Standard Finished Opening Sizes
48 x 96 (2 Door)
60 x 96 (2 Door)
72 x 96 (2 Door)
84 x 96 (2 Door)
96 x 96 (2 Door)
108 x 96 (3 Door)
120 x 96 (3 Door)
144 x 96 (3 Door)
192 x 96 (4 Door)

----- 3 Stock Frame Colors -----

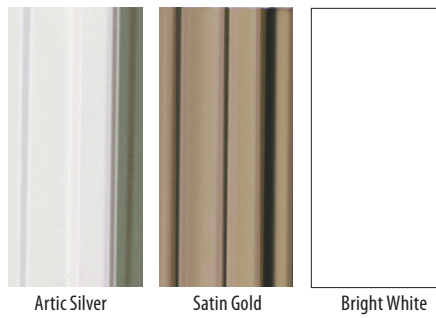

3-4mm Bottom Roll Framed Sliding Door System

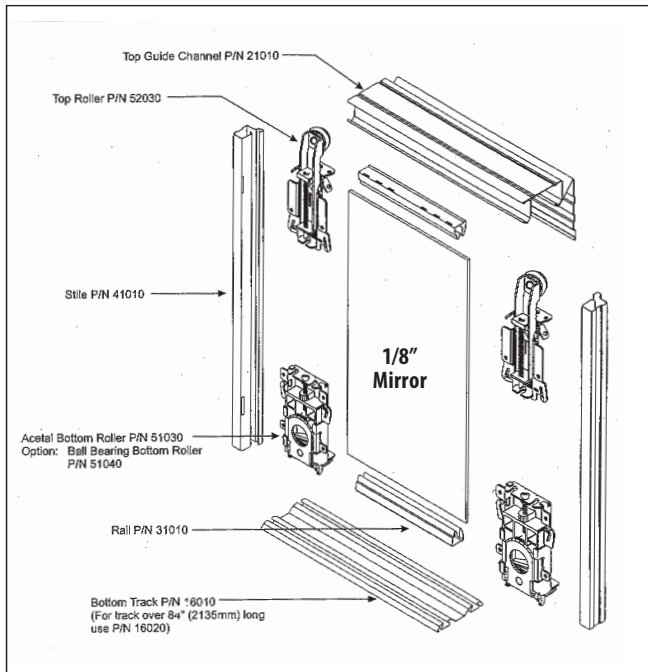

Custom Sizes Available

BIFOLD FRAMED MIRRORED CLOSET DOORS

Standard Finished Opening Sizes
24 x 96 (2 Door)
30 x 96 (2 Door)
36 x 96 (2 Door)
48 x 96 (4 Door)
60 x 96 (4 Door)
192 x 96 (4 Door)

Standard Finished Opening Sizes
24 x 80 1/2 (2 Door)
30 x 80 1/2 (2 Door)
36 x 80 1/2 (2 Door)
48 x 80 1/2 (4 Door)
60 x 80 1/2 (4 Door)
192 x 80 1/2 (4 Door)

----- 2 Stock Frame Colors -----



Framed Bifold Door System

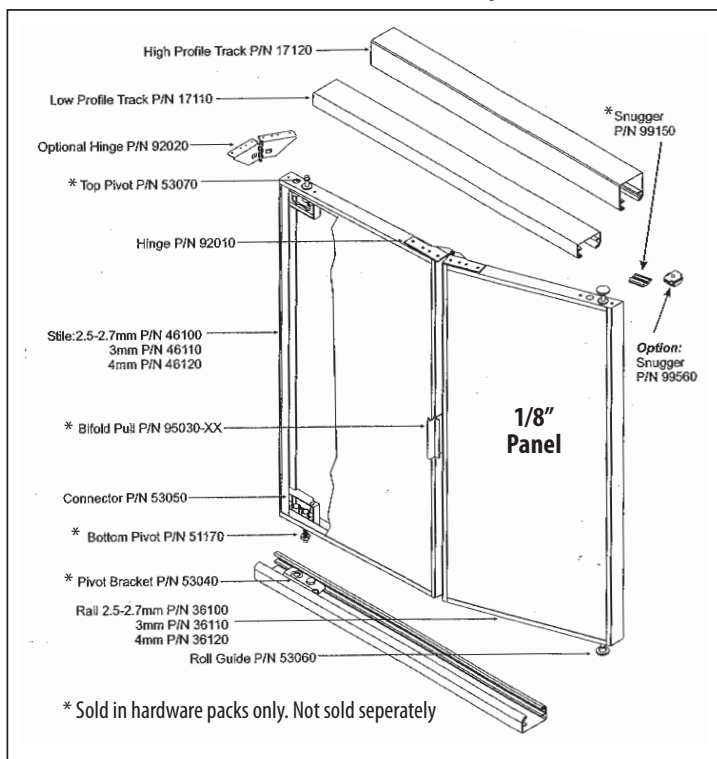

Custom Sizes Available

FRAMELESS BYPASS MIRRORED CLOSET DOORS

Standard Finished Opening Sizes

48 X 80 1/2 (2 Door)
60 X 80 1/2 (2 Door)
72 X 80 1/2 (2 Door)
84 X 80 1/2 (2 Door)
96 X 80 1/2 (2 Door)
108 X 80 1/2 (3 Door)
120 X 80 1/2 (3 Door)
144 X 80 1/2 (3 Door)
192 X 80 1/2 (4 Door)

Standard Finished Opening Sizes

48 x 96 (2 Door)
60 x 96 (2 Door)
72 x 96 (2 Door)
84 x 96 (2 Door)
96 x 96 (2 Door)
108 x 96 (3 Door)
120 x 96 (3 Door)
144 x 96 (3 Door)
192 x 96 (4 Door)

----- 3 Stock Frame Colors -----

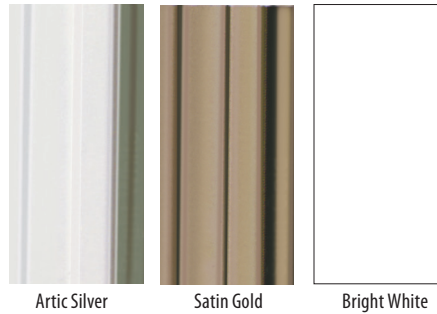

3-4mm Bottom Roll Frameless Sliding Door System

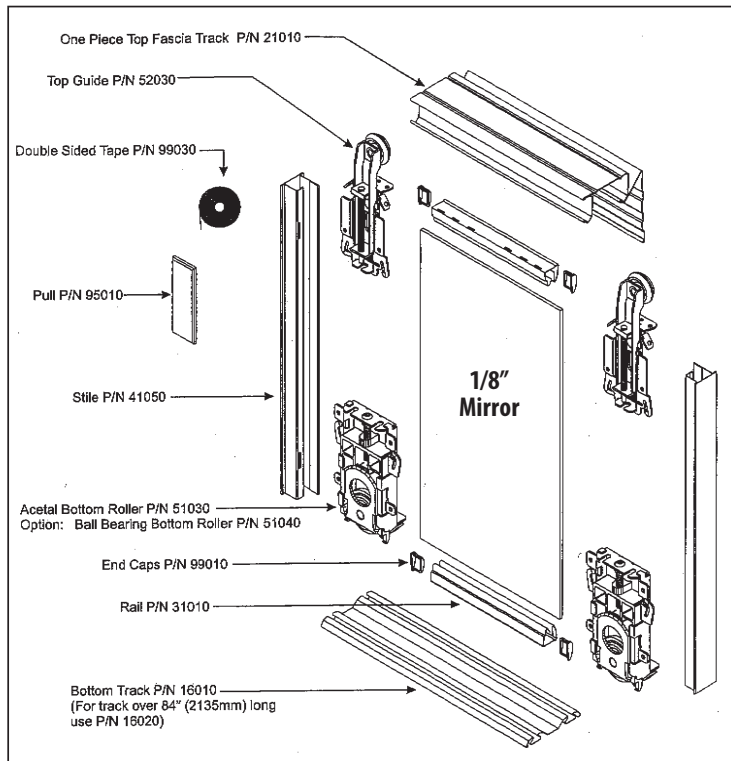

Custom Sizes Available

FRAMELESS BIFOLD MIRRORED CLOSET DOORS

Standard Finished Opening Sizes
24 x 96 (2 Door)
30 x 96 (2 Door)
36 x 96 (2 Door)
48 x 96 (4 Door)
60 x 96 (4 Door)
72 x 96 (4 Door)

Standard Finished Opening Sizes
24 x 80 1/2 (2 Door)
30 x 80 1/2 (2 Door)
36 x 80 1/2 (2 Door)
48 x 80 1/2 (4 Door)
60 x 80 1/2 (4 Door)
72 x 80 1/2 (4 Door)

----- 2 Stock Frame Colors -----



Framed Bifold Door System

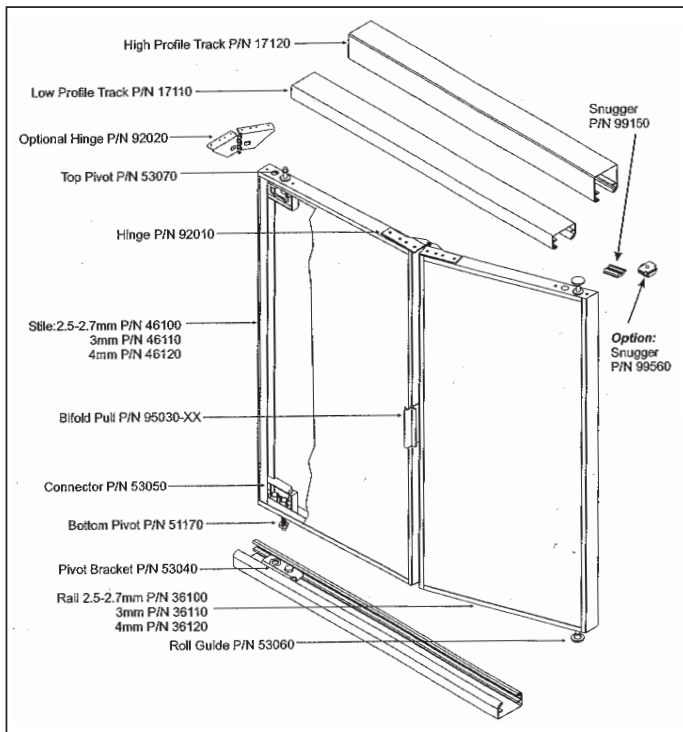

Custom Sizes Available

Are your entries dark?

Are you tired of painting your old entries?

Beautify and update your entries with new maintenance free aluminum doors and frames.



Stock Colors: Bronze anodized and clear anodized. Other anodized and painted colors available.



TABBED PAGE

TABBED PAGE

Index	Page
Commercial Steel Lite Kits	4
20 Minute Steel	3
20 Minute Wood	1
90 Minute Commercial Steel	3
90 Minute Wood	2

20 MINUTE FIRE RATED WOOD DOORS

- Fire doors must be machined by EMPIRE as dictated by law.
- All fire doors are 1-3/4", oversized 3/16" in width.
- 60 and 90 minute doors may be trimmed in height up to 3/4". 20 minute doors can be trimmed to any size.



	Unfinished Red Oak	Legacy Lite Oak	Legacy Mendocino	Legacy Natural Oak	Legacy Walnut
2-0 x 79-1/4	★	---	---	---	---
2-4 x 79-1/4	★	---	---	---	---
2-6 x 79-1/4	★	---	---	---	---
2-8 x 79-1/4	★	---	---	---	---
3-0 x 79-1/4	Stock	Stock	Stock	Stock	Stock
3-6 x 79-1/4	★	---	---	---	---
3-8 x 79-1/4	★	---	---	---	---
4-0 x 79-1/4	★	---	---	---	---
3-0 x 80	Stock	Stock	Stock	Stock	Stock
2-8 x 83-1/4	★	---	---	---	---
3-0 x 83-1/4	★	---	---	---	---



	Hardboard Flush Primed	A6 Primed Solid Core (smooth or textured)	White Birch	White Maple
2-0 x 79-1/4	★	★	★	★
2-4 x 79-1/4	★	★	★	★
2-6 x 79-1/4	★	★	★	★
2-8 x 79-1/4	★	★	★	★
3-0 x 79-1/4	★	★	★	★
3-6 x 79-1/4	★	★	★	★
3-8 x 79-1/4	★	★	★	★
4-0 x 79-1/4	★	★	★	★
2-8 x 83-1/4	★	★	★	★
3-0 x 83-1/4	★	★	★	★

--- Special Order
 ★ Call for lead time
 Custom Painting, Staining and sizes available.

See page 2 in the door section for door measuring guide.

60/90 MINUTE FIRE RATED WOOD DOORS

- Fire doors must be machined by EMPIRE as dictated by law.
- All fire doors are 1-3/4", undersized 3/16" in width.
- 60/90 minute fire doors may be trimmed in height up to 3/4"

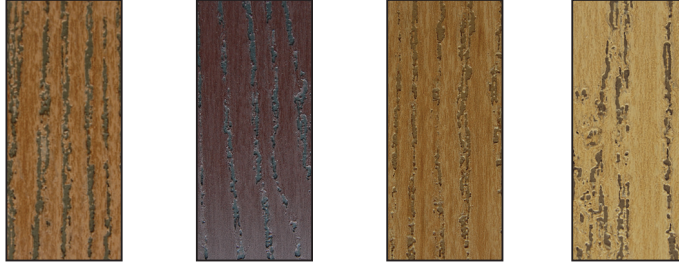

60 Minute - Use 90 minute rated doors for 60 minute applications.

	Legacy Natural Oak	Legacy Walnut	Legacy Mendocino	Legacy Lite Oak
2-8 x 79-1/4	★	★	★	★
3-0 x 79-1/4	Stock	Stock	Stock	Stock
3-0 x 83-1/4	★	★	★	★



	White Maple	White Birch	Red Oak	Primed Hardboard
2-8 x 79-1/4	★	★	★	★
3-0 x 79-1/4	★	★	Stock	★
3-0 x 83-1/4	★	★	★	★

See page 2 in the door section for door measuring guide.

★ Call for lead time
Custom Painting, Staining and sizes available.

20 MINUTE FIRE RATED STEEL DOORS

20 Minute Fire Rated

Standard Frame Configuration: 4-9/16" Frame Saver® rot-proof primed exterior frame with 20 minute metal label, Q-Lon Fire Rated weatherstrips, Z-series inswing adjustable composite sill with sill cover, one plain hinge, two spring hinges, and applied rot-proof brick mould. The door also has a 20 Minute Metal Label.

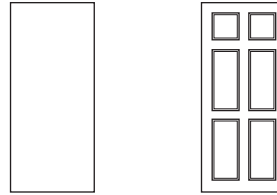

	Size	Steel Edge HTG-HDA	Steel Edge HTG-HDG
Pre-hung Unit	2-6 x 6-8	★	★
Pre-hung Unit	2-8 x 6-8	★	★
Pre-hung Unit	3-0 x 6-8	★	★

Steel edge doors are 24 gauge steel.
Custom painting available.

90 MINUTE FIRE RATED 18 GAUGE COMMERCIAL STEEL DOORS

90 Minute Fire Rated

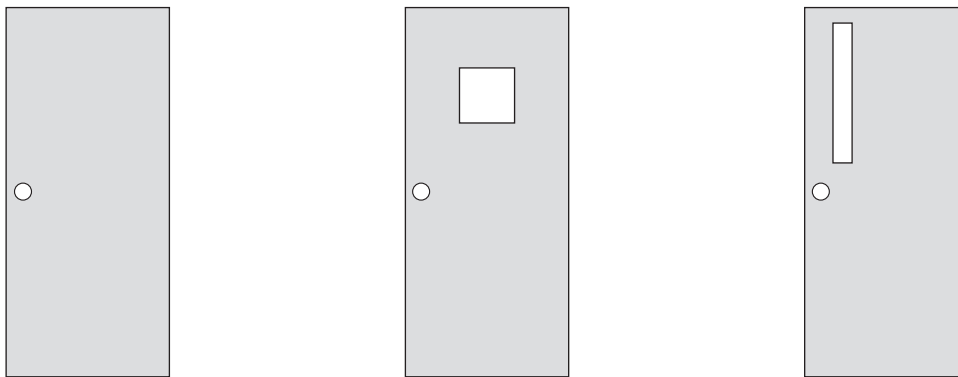

Standard Door Sizes
Widths 2'6, 2'8, 3'0, 3'4, 3'6.
Heights 6'8, and 7'0
 Custom Sizes Available.

(For frames see page 2 in the Fire Rated Frame section)

COMMERCIAL STEEL LITE KITS

Model VLF-EZ Beveled VISION LITE with continuous glass retainer

Recommended for applications where total visibility and light transmissions are required.

Specifications

Standard Features:

Material: 20 Gauge CRS frame.

Construction: Mitered and welded corners, beveled return, continuous glass retainer, countersunk mounting holes. Screws fasten from room side into prepunched mounting holes. This mounting method leaves corridor side of frame free of fasteners for aesthetic and security purposes.

Finish: Mineral bronze baked on powder coat.

Door: For 1-3/4" door.

Fasteners: #8 x 7/8" flathead phillips head SMS.

Glass: Use 3/16", 1/4" fire rated glazing with Warnock Hersey (ITS) or U.L. classification markings for fire rated applications.



Order to cut size

6 x 27

12 x 12

24 x 30

24 x 36

24 x 36

24 x 54

24 x 62

12 x 12

24 x 30

24 x 36

24 x 62

24 x 66

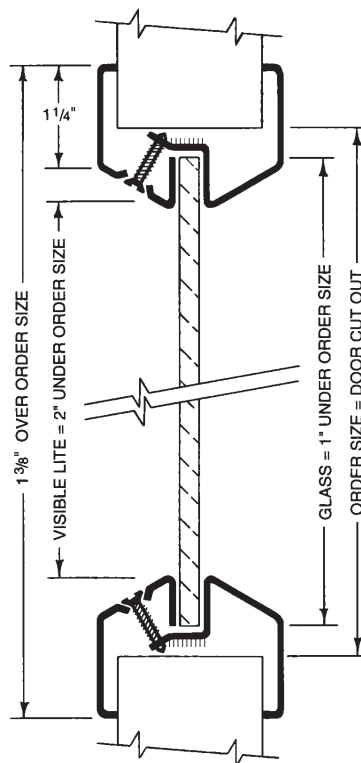

Model VLF-EZ-IG Beveled VISION LITE with continuous glass retainer

Recommended for applications requiring fire rated, safety, and or insulated glazing up to 1" thick.

Specifications

Standard Features:

Material: 20 Gauge CRS frame.

Construction: Mitered and welded corners, beveled return, continuous glass retainer, countersunk mounting holes. Screws fasten from room side into prepunched mounting holes. This mounting method leaves corridor side of frame free of fasteners for aesthetic and security purposes.

Door: For 1-3/8" door up to 2 1/2" thick.

Finish: Mineral bronze baked on powder coat.

Fasteners: #8 x 7/8" flathead phillips head SMS.

Glass: Use 1/4" - 1" thick glass. Please specify glass thickness when ordering.



Order to cut size

6 x 27

12 x 12

24 x 30

24 x 36

24 x 36

24 x 54

24 x 62

12 x 12

24 x 30

24 x 36

24 x 62

24 x 66

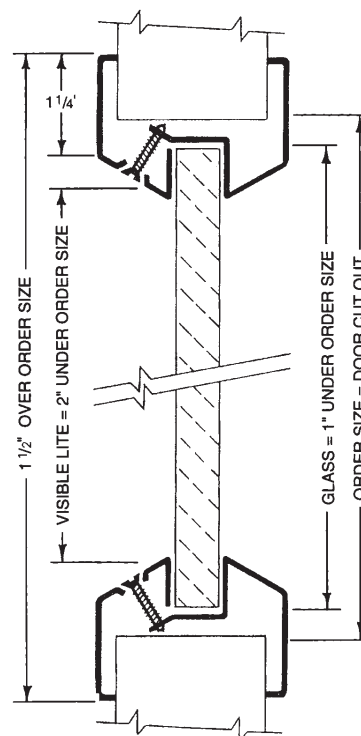

60 & 90 minute fire doors cannot exceed 100 square inches of exposed glass.

20 minute fire doors cannot exceed 1296 square inches of exposed glass.

Fire rated glass must be used in all fire rated doors.

TABBED PAGE

TABBED PAGE

Index	Page
Commercial Steel Frames.....	2
Exterior Pine Frames.....	1
Magnetic Weatherstrip	1
Oak Flats Jams.....	1
Q-Lon Weatherstrip	1
Rediflex	4
Rediframes.....	3
Smoke Seal	1
Thresholds	1

FIRE RATED FRAMES

20 Minute Flat Oak Unfinished Jambs with Fire Label

Jamb sets are set up & machined to standard specifications, no sill included. Not for use in exterior applications.

Size	Solid Oak 3-0 x 7-0	Hard Edge Oak Veneer* 3-0 x 7-0	Maple 3-0 x 7-0
4-9/16"	★	---	★
4-13/16"	---	★	---
4-7/8"	★	---	★
5-1/4"	★	---	★
5-3/8"	---	★	---
6-9/16"	★	---	★
6-13/16"	★	---	★
7-1/4"	★	---	★

* Call for lead time, --- special order.
★ Hard-Edge jambs cannot be trimmed in width. For custom widths, use solid oak jambs.

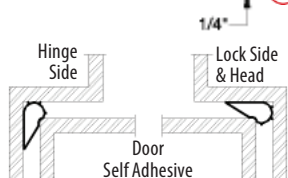
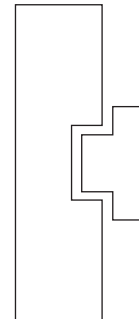

797B
Black Polyprene Self Adhesive
Weatherstrip Polypren Insert, UL
Listed Length: 17 and 21 feet

Part Number 797B

797B-19 Smoke Seal

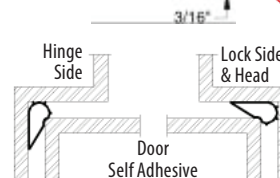

638CH
Smoke Silicone Self Adhesive
Weatherstrip Silicone Insert, UL
Listed Length: 19 feet

Part Number 638CH

638CH-19FT Smoke Seal

20 Minute Exterior Pine Frame With Fire Label and Q-Ion Weatherstrip

Jamb sets are set up & machined to standard specifications, no sill is included. Not for use in exterior applications. Specify unfinished or primed.

Size
4 9/16"
4 13/16"
5 1/4"
6 9/16"
6 13/16"

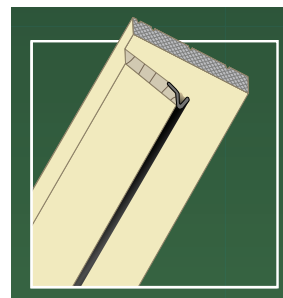

For Casing Go to
Moulding Section

* Custom sizes available * Custom painting available



Weatherstrip - Short Reach (standard on exterior units)		
#WSCS30B	Bronze	3-0 pc
#WSCC68B	Bronze	3-0 pc
#WSCC80B	Bronze	8-0 pc
#WSCC68W	White	6-8 pc
#WSCC80W	White	8-0 pc

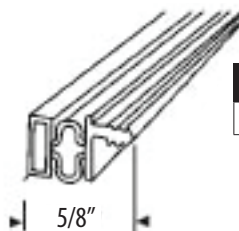

Weatherstrip - Magnetic		
#WSM68	Bronze	6-8 pc



Aluminum Threshold

#S204A-36 4 x 1/2



Oak Mini-Threshold

#30KMT-36' 3/4 x 1-11/16



3 1/2" 800-36



3 1/2" 8001V-36

COMMERCIAL STEEL 16 GAUGE FRAMES

Knockdown (KD) Frames

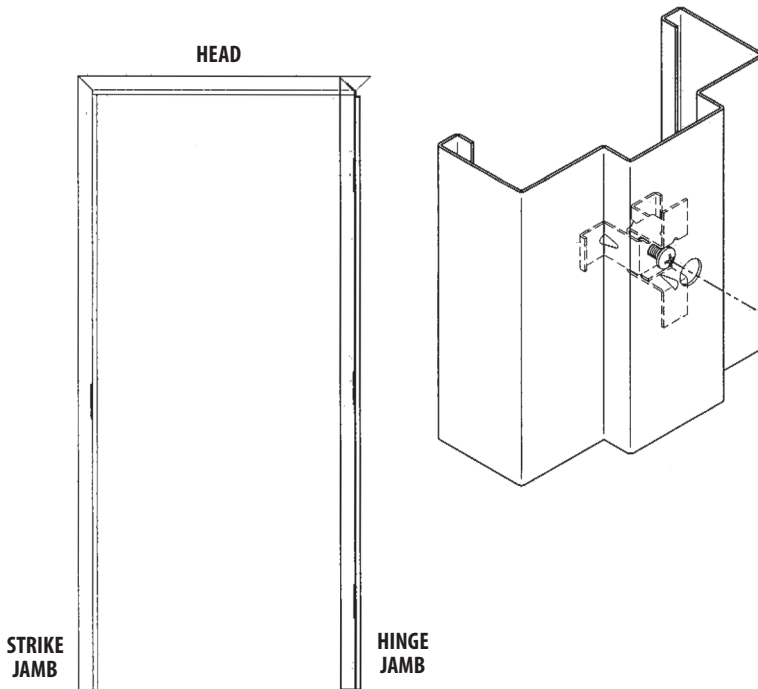

- A frame is made of three members, two jambs and one head.
- A Comprehensive Anchor is used to compress the header between the two joints.
- As the adjustment screw is turned, the anchor pushes against the stud wall and locks the header in place.
- It is also known as a Pressure Anchor.
- This anchor is used on drywall frames, and in conjunction with the Snap-In Drywall Sill Anchor.

Welded Frames

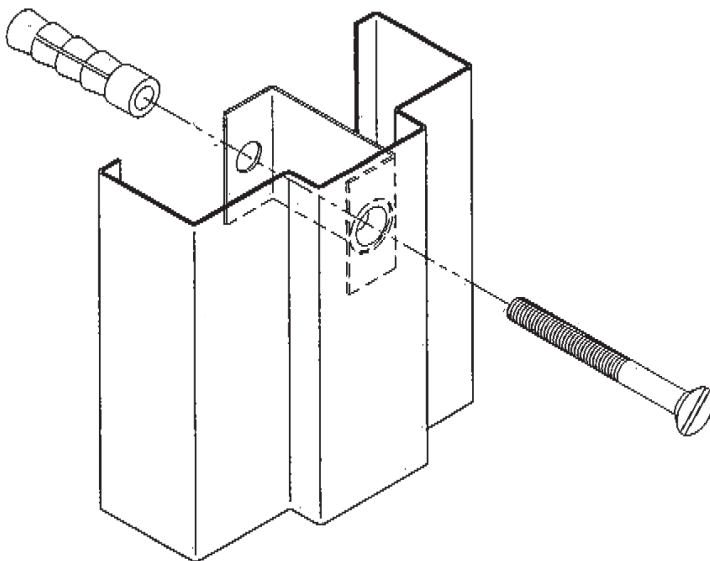

- These 1 piece frames come with a standard 2" face
- Non- standard FACE dimensions are available upon request. 1"-1 1/4"-1 1/2"
- Punched & Dimpled Frames may be required, depending on the type of anchor used.

Need Help?
Ask your sales representative to come visit you

Standard Jamb Thickness 4 3/4 - 5 3/4 - 6 1/4 - 6 3/4 - 7 1/4 - 7 3/4 - 8 3/4
90 minute lables available for fire rated applications.
For commercial steel doors see page 3 in the Fire Door section.

REDIFRAME STEEL FRAMES

Brown or Ivory colors are standard

Single Door	Gauge	Hinge Prep	Swing	Set 1 Hdr & 2 Uprts	Components Uprts / Ea	Components Header / Ea
4-3/4" x 6-8						
SET 31 Single Strike	20	4-1/2" - Sq Corner	Reversible LH or RH	2-8, 3-0	6' 8	2-8, 3-0
SET 31 Double Strike	20	4-1/2" - Sq Corner	Specify LH or RH			
4-7/8" x 6-8						
SET 3 Single Strike (for 1-3/8" door)	20	3-1/2" Radius	Reversible LH or RH	2-8, 3-0, 3-6	6' 8	2-8, 3-0, 3-6
SET 31 Single Strike	20	4-1/2" Sq Corner	Reversible LH or RH			
SET 31 Double Strike	20	4-1/2" Sq Corner	Specify LH or RH			
4-7/8" x 7-0						
SET 31 Single Strike	20	4-1/2" Sq Corner	Specify LH or RH	2-6, 2-8, 3-0, 3-6	6' 8	2-6, 2-8, 3-0, 3-6
5-3/8" x 6-8						
SET 31 Single Strike	20	4-1/2" Sq Corner	Reversible LH or RH	2-8, 3-0	6' 8	2-8, 3-0
SET 31 Double Strike	20	4-1/2" Sq Corner	Specify LH or RH			
6-7/8" x 6-8						
SET 31 Single Strike	18	4-1/2" Sq Corner	Reversible LH or RH	2-8, 3-0	6' 8	2-8, 3-0
SET 31 Double Strike	18	4-1/2" Sq Corner	Specify LH or RH			
7-3/8" x 6-8						
SET 31 Single Strike	18	4-1/2" Sq Corner	Reversible LH or RH	3-0	6' 8	3-0
SET 31 Double Strike	18	4-1/2" Sq Corner	Specify LH or RH			

Rediframe Specs

SET 3 hinge prep = Three 3 1/2" w/1/4" radius corners
 SET 31 hinge prep = Three 4 1/2" w/square corners
 SET 33 hinge prep = Six 4 1/2" w/square corners

Color:

Rediframe Brown and Ivory

Door Size:

1-3/4" Thickness (Set 3 = 1 3/8")

Casing:

1-1/4" Flat Steel

Strike Prep:

1-1/4" x 2-3/4" T-strike

Dead Strike Prep:

8" OC above T-strike

Rediframe Options

- #RFRB Closer Reinforce Bracket
- #RFDBS4 Dead Bolt Strike Plate - US4
- #RFDBS2 Dead Bolt Strike Plate - US26D
- #RFDBSO Dead Bolt Strike Plate - US10B
- #RFDBSCB Dead Bolt Strike Center
- #RF30CS Rediframe Casing Set

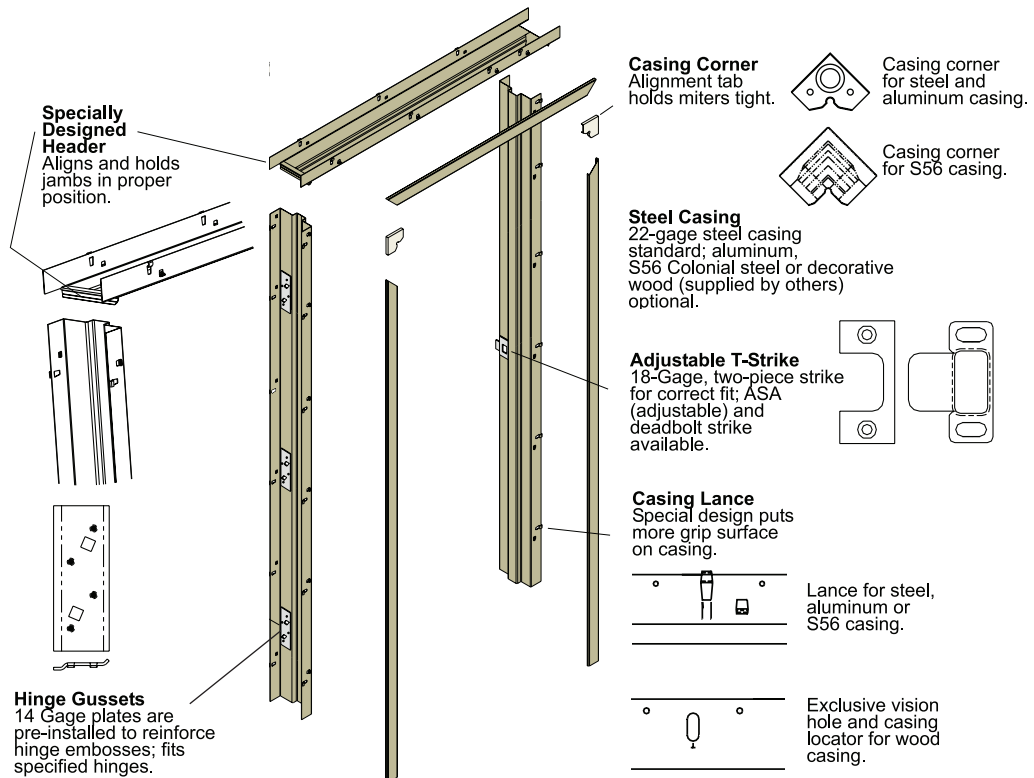

These frames meet a 90 minute fire rating.

REDIFLEX STEEL FRAMES

Brown or Ivory colors are standard

Single Door Non-Kerfed	Gauge	Hinge Prep	Swing	Set 1 Hdr & 2 Uprts	Components Uprts / Pr	Components Header / Ea
4 to 5-1/4" x 6-8"						
SET 31 Double Strike	18	4-1/2" - Sq Corner	Specify LH or RH	2-6, 2-8, 3-0	6-8'	2-6, 2-8, 3-0
6 to 7-1/4" x 6-8"						
SET 31 Double Strike	18	4-1/2" Sq Corner	Specify LH or RH	2-8, 3-0	6-8'	2-8, 3-0

Rediflex Specs

SET 31 hinge prep = Three 4-1/2" w/square corners
Color: Rediframe Brown and Ivory
Door Size: 1-3/4" Thickness
Casing: 1-1/4" Flat Steel
Strike Prep: 1-1/4" x 2-3/4" T-strike
Type: NOT Kerfed for weatherstrip
Gauge: 18

Rediflex Options

#RFRB Closer Reinforce Bracket
 #RFDBS4 Dead Bolt Strike Plate - US4
 #RFDBS2 Dead Bolt Strike Plate - US26D
 #RFDBS0 Dead Bolt Strike Plate - US10B
 #RFDBSCB Dead Bolt Strike Cover
 #RF30CS Rediframe Casing Set

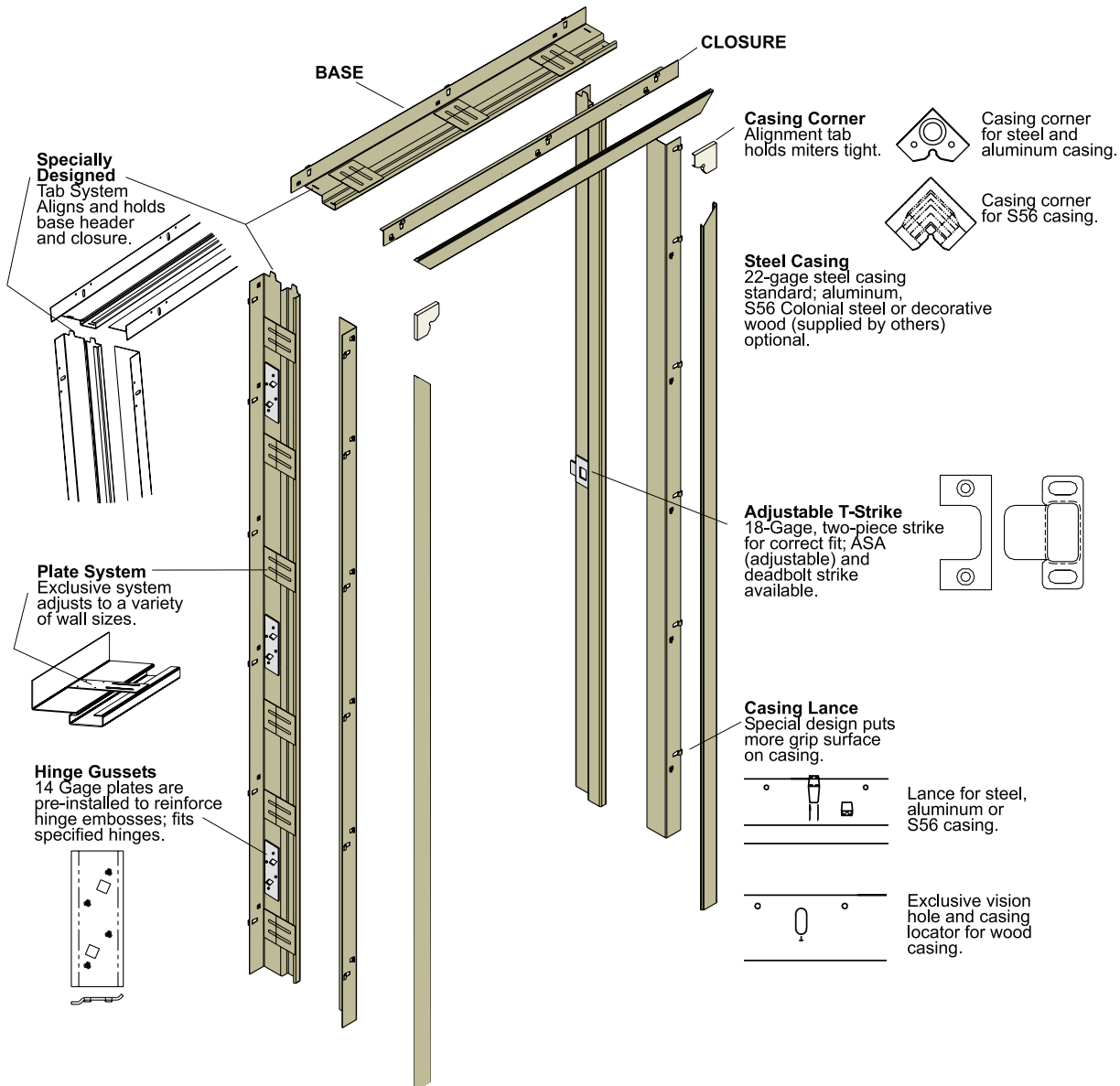

These frames meet a 90 minute fire rating.